

Suqaring Bracket sets provide parallel attachment points for a variety of Yokes.

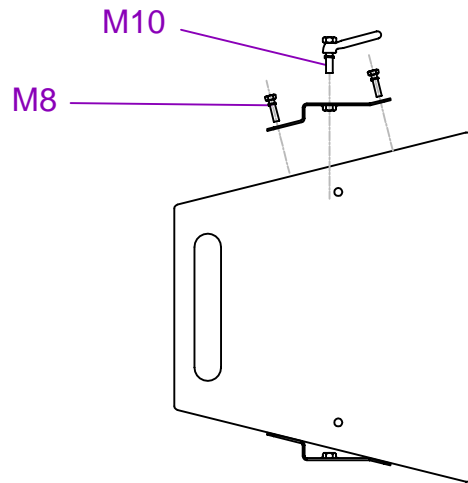

- Kits contain:
 2 x Squaring Brackets
 4 x M8x30 Hex Bolt
 4 x M8 Split Washer
 4 x M8 A-Form Washer
 2 x M10 Split Washer
 AND
 2 x M10x30 Hex Bolt (Kit 1)
 OR
 2 x M10x40 Hex Lever Bolt (Kit 2)

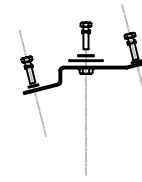

SB2-K1

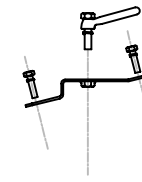

SB2-K2

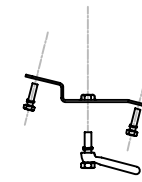
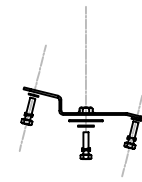

All dimensions in mm and inches

Copyright Funktion-One Research Ltd

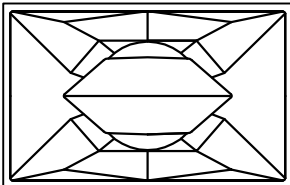

FUNKTION-ONE

Hoyle, Horsham Road, Beare Green, Dorking, Surrey, RH5 4PS, England

Phone: +44 (0)1306 712820

Fax: +44 (0)1306 711240



mail@funktion-one.com

www.funktion-one.com

Accessories for: Resolution 2

SB2-K1 - Squaring Bracket (pair) - including bolts to attach to R2 and yoke

SB2-K2 - Squaring Bracket (pair) - including bolts to attach to R2 and lever bolts for yoke

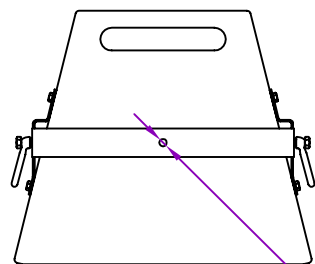

Ø13mm
[Ø1/2"]

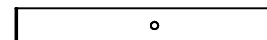

M8 hole, one side only,
can be used for safety
attachment.



Ø10mm
[Ø3/8"]

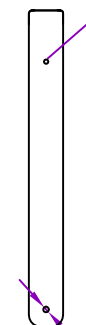

466mm
[1'-6 3/8"]

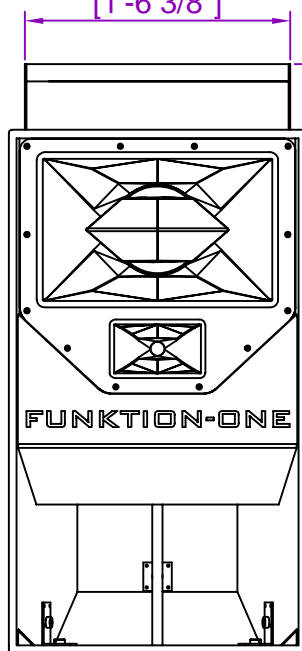

1035mm
[3'-4 3/4"]

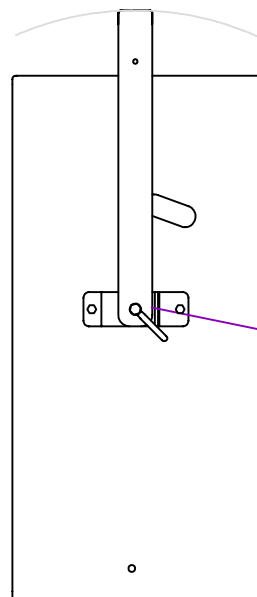

YS2 used for top
suspension only (hanging)

Attaches to R2 with
SB2 kit (separate)

All dimensions in mm and inches

Copyright Funktion-One Research Ltd

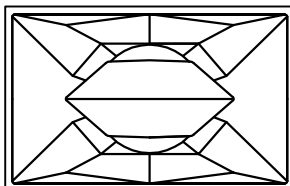

FUNKTION-ONE

Hoyle, Horsham Road, Beare Green, Dorking, Surrey, RH5 4PS, England

Phone: +44 (0)1306 712820

Fax: +44 (0)1306 711240



mail@funktion-one.com

www.funktion-one.com

Accessories for: Resolution 2

YS2 - Simple Yoke for R2 (top suspension) needs SB2 kit

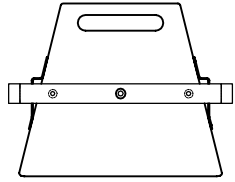

Ø13mm Hole for Stand Top
Adaptor or other flying apparatus

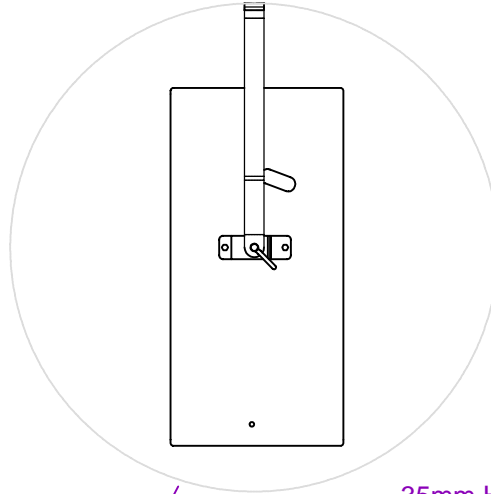
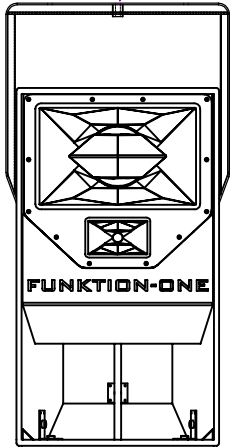

YU2 - Universal Yoke is wide enough to allow cabinet to fully rotate between the supporting arms.

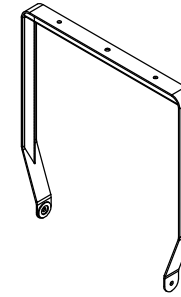

YU2

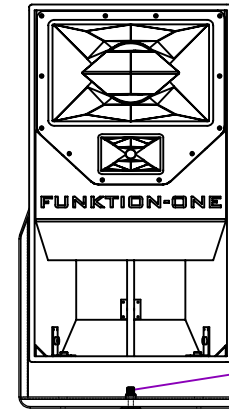

35mm Heavy Duty Stand
Top Adaptor

35mm stand

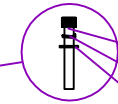

M12x80 Cap Head Machine Screw
M12 Split Washer
M12 C-Form Washer
M8 Wing Knob

All dimensions in mm and inches

Copyright Funktion-One Research Ltd

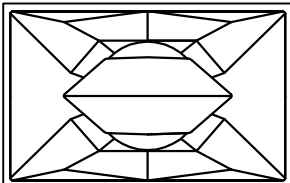

FUNKTION-ONE

Hoyle, Horsham Road, Beare Green, Dorking, Surrey, RH5 4PS, England

Phone: +44 (0)1306 712820

Fax: +44 (0)1306 711240



mail@funktion-one.com

www.funktion-one.com

Accessories for: Resolution 2

YU2 - Universal Yoke for R2 (for either top or bottom suspension)
needs SB2 kit

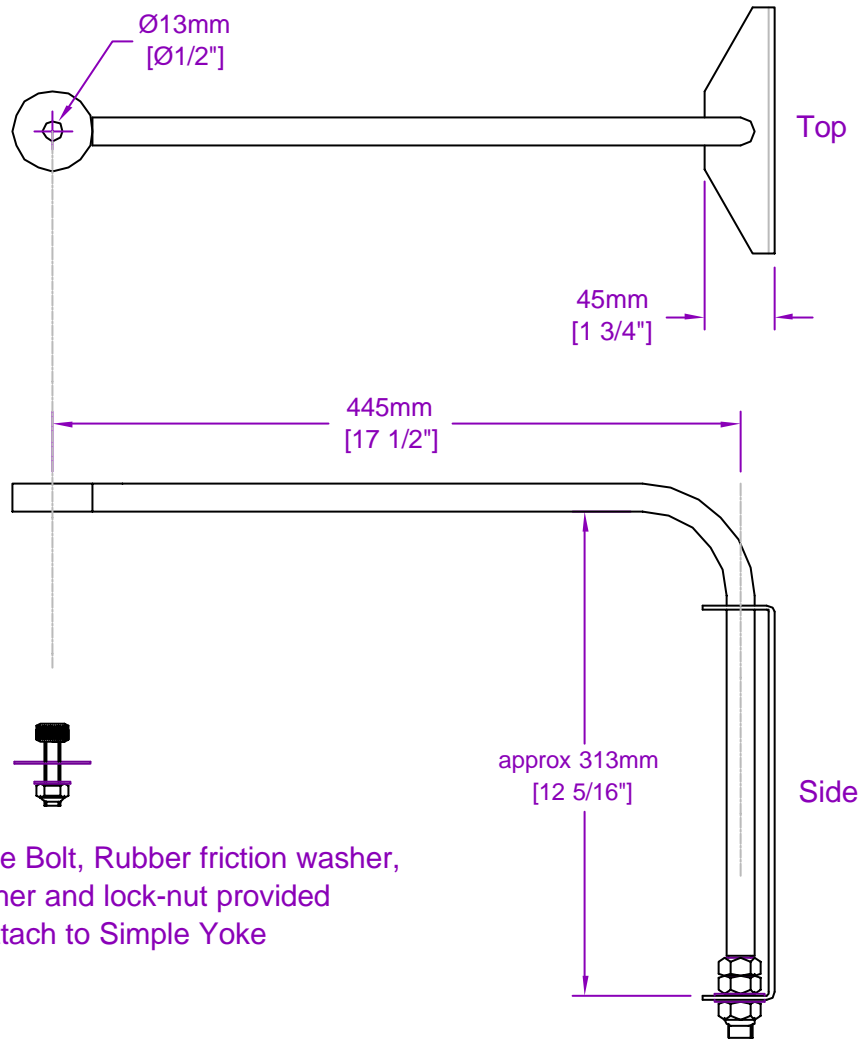

Note: The installer should ensure that the Wall Mounting is securely and appropriately fixed.

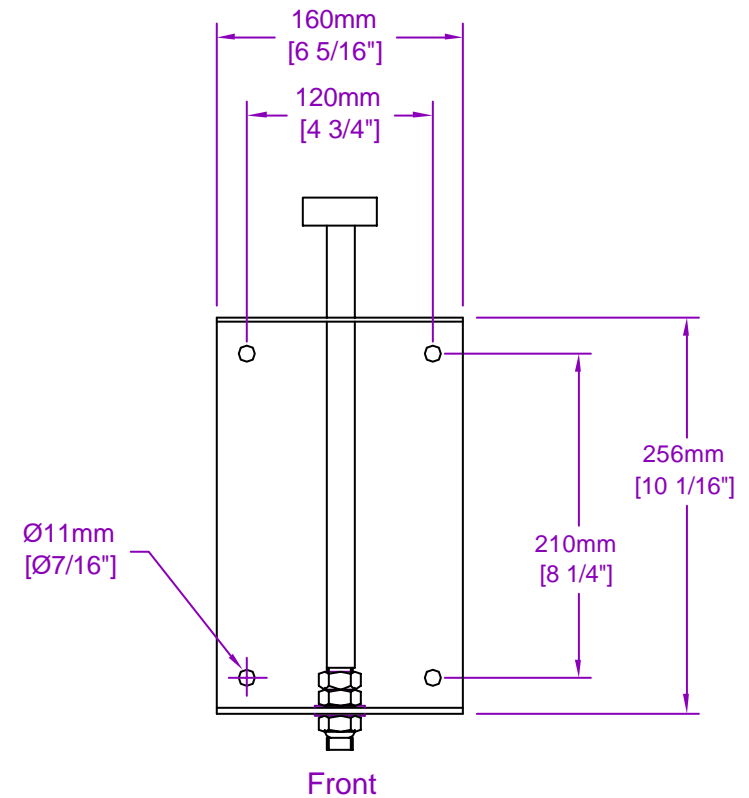

M12 High-tensile Bolt, Rubber friction washer, plain washer and lock-nut provided to attach to Simple Yoke

All dimensions in mm and inches

Copyright Funktion-One Research Ltd

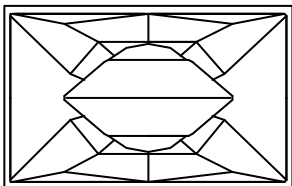

FUNKTION-ONE

Hoyle, Horsham Road, Beare Green, Dorking, Surrey, RH5 4PS, England

Phone: +44 (0)1306 712820

Fax: +44 (0)1306 711240



mail@funktion-one.com

www.funktion-one.com

Accessories for: Resolution 2

WM2 - Heavy duty yet elegant wall mount bracket for R2 allowing full pan and tilt needs YS2 and SB2 kit

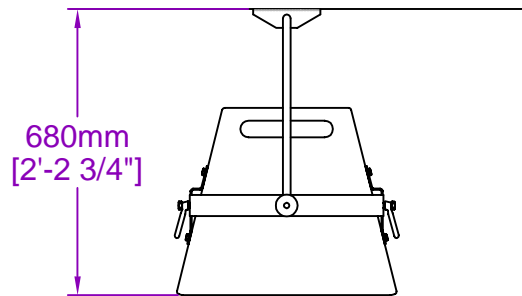
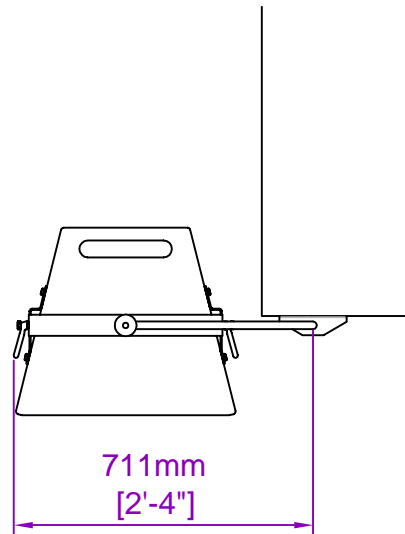
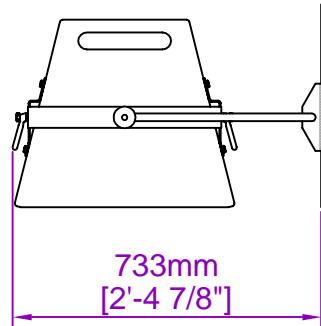

As shown, the WM2 wall bracket is very versatile, making it ideal for many applications.

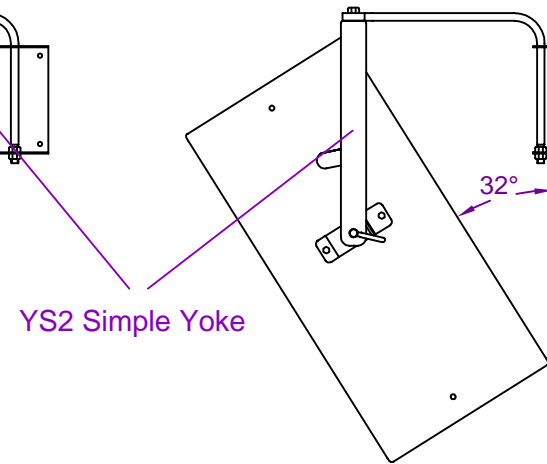
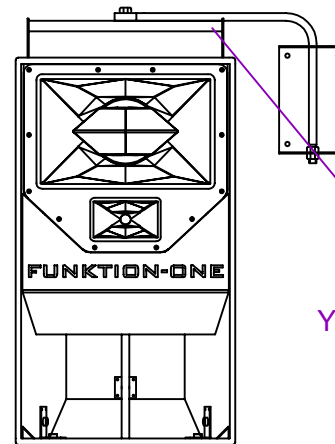

All dimensions in mm and inches

Copyright Funktion-One Research Ltd

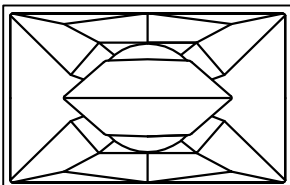

FUNKTION-ONE

Hoyle, Horsham Road, Beare Green, Dorking, Surrey, RH5 4PS, England

Phone: +44 (0)1306 712820

Fax: +44 (0)1306 711240



mail@funktion-one.com

www.funktion-one.com

Accessories for: Resolution 2

WM2 - Heavy duty yet elegant wall mount bracket for R2 allowing full pan and tilt needs YS2K and SB2K